

Contents

Chapter 1: Desktop CPEi 725 User Guide

Overview	1-1
Powerful Features in a Single Unit	1-1
Front of the CPE	1-2
Back of the CPE	1-2
Operating Information	1-3

Chapter 2: Installation

Overview	2-1
Before you Begin	2-1
Easy Setup	2-1
Advanced Setup	2-2
Procedure to Log into the CPE	2-2
Setup Wizard and Authentication	2-3

Chapter 3: Basic Configuration

Personalize Menu	3-1
Password Tab	3-2
Device Time Tab	3-2
Device Name Tab	3-2
Restore Factory Settings Tab	3-3
Internet Menu	3-3
WiMAX Security Tab	3-4
Firewall Tab	3-4
Dynamic DNS Tab	3-5
Status Menu	3-5
Telephony Menu	3-6

Chapter 4: Advanced Configuration

Port Forwarding Menu	4-1
Forwarding Tab	4-2
Local Address Menu	4-2
DHCP Server Tab	4-3
Lease Status Tab	4-4
Lease Reservation Tab	4-4
Control Panel	4-5
Software Tab	4-6
Certificate Tab	4-6
System Tab	4-6

About Tab	4-7
-----------------	-----

Chapter 5: Configuring TCP/IP

Configuring TCP/IP in Windows 2000	5-1
Configuring TCP/IP in Windows XP	5-5

Chapter 6: Troubleshooting

Power LED is Off	6-1
A Computer Cannot Log On to the CPE	6-1
Cannot Connect to the Internet	6-1
Additional Troubleshooting Help	6-1

Chapter 7: Important Safety and Legal Information

This Product complies with the following RF energy exposure standards and guidelines: ..	7-1
RF Exposure Compliance and Guidelines Operating Instructions	7-1
FCC Regulatory Information	7-1
Industry Canada Statement	7-2
EU Declaration of Conformity	7-3
Caring for the Environment	7-3
Disposal of Motorola Equipment in EU Countries	7-4
Disposal of Motorola Networks Equipment in Non-EU countries	7-4
CMM Disclosure	7-4
Copyrights and Trademarks	7-5
Copyrights	7-5
Usage and Disclosure Restrictions	7-5

Chapter 1: Desktop CPEi 725 User Guide

Overview

Thank you for purchasing the Motorola CPE Indoor (CPEi) 725 desktop device. The Desktop CPEi allows you to connect to the wireless world easily and seamlessly without complicated installation and setup procedures. In addition, it offers you the ability to make Voice over Internet Protocol (VoIP) calls.

The Desktop CPE indoor (CPEi) device provides the user:

- Convenience - with easy plug and play functionality. Compact design.
- Control - remote management capability allows easy detection and authentication once the unit is set up.
- VoIP - One RJ11 ports allow for Voice over IP calls using your CPEi 725

The features and the physical appearance of your Desktop CPEi device may differ slightly from the illustration.

Figure 1-1: CPEi 725



For the most recent documentation, visit the Product Documentation page on www.motorola.com.

Powerful Features in a Single Unit

The CPE device provides the following features:

- WiMAX Authentication
- WAN DHCP Client
- LAN DHCP Server
- Home Gateway Functions
- Firewall Protection
- Port Forwarding

Front of the CPE

The front of the CPE unit contains LED Link/Activity indicators. The LEDs provide the status of the unit and signal strength indicators for easy adjustment during setup.

Table 1-1 LED Indicator Interface

LED	Status
Signal Strength	<p>Full WiMAX Signal Strength is detected when all WiMAX Signal Strength LEDs are lit.</p> <ul style="list-style-type: none"> • All WiMAX Signal Strength LEDs are off - very low signal detected. • One to two WiMAX Signal Strength LEDs are lit - low signal detected. • Three to five WiMAX Signal Strength LEDs are lit - high signal detected.
WAN WiMAX	<p>While acquiring access to the WiMAX Network:</p> <ul style="list-style-type: none"> • All WiMAX Signal Strength LEDs vary between ON, OFF and/or BLINKING status.

CAUTION

If all five WiMAX Signal Strength LEDs are blinking, then a software upgrade is in progress. Do NOT remove power to the CPE.

Back of the CPE

The back of the CPE unit contains the reset switch, AC Power Connector, Ethernet connector, Ethernet LED and telephone port.

Figure 1-2: CPE Ports and Connections

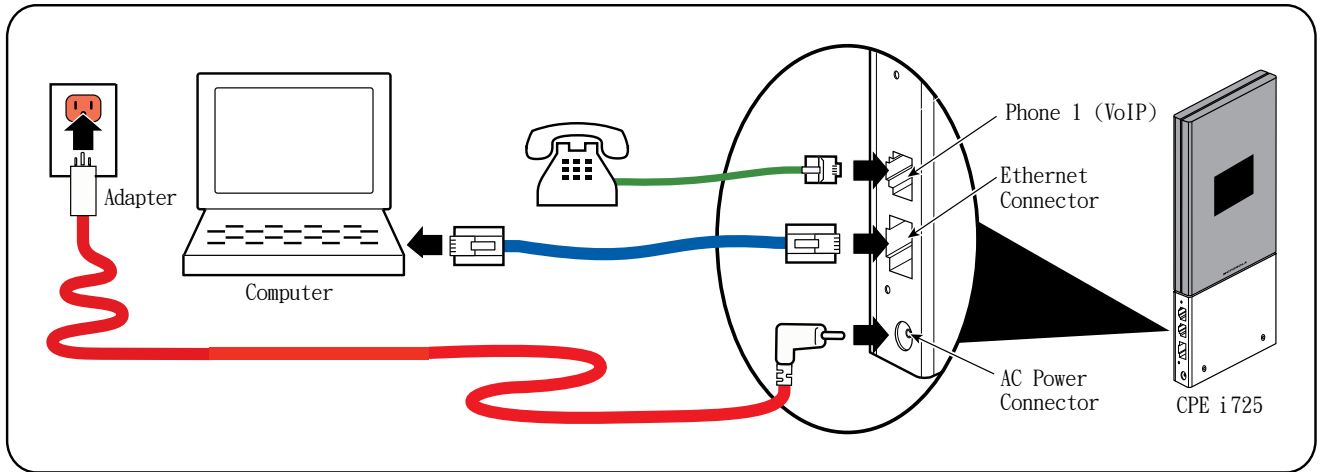

Table 1-2 Port Descriptions

Port	Port Description
Ethernet	Ethernet Port
Power	AC Power Connector
Reset	Hardware Reset Button (A paperclip is recommended for accessing this button).
Phone Line	RJ-11 port for use with VoIP.

Operating Information

Operating temperature for this unit is 0-40 °C (32-104 °F).

Chapter 2: Installation

Overview

To install the Desktop CPEi 725 Series, review the following sections:

- Before You Begin
- Easy Setup

Before you Begin

Before you begin installation, check that you have received the following items with your Desktop CPEi 725:

Table 2-1 In the box with your CPE, you should have

Item	Description
AC Adapter	Power adapter and cord connects the Desktop CPE to an AC electrical outlet.
Ethernet Cable	The Ethernet cable connects the Internet port on your Desktop CPE to your PC or laptop computer.
Desktop CPEi 725 Quick Start Guide	Desktop CPEi 725 Quick Start Guide

In addition, you need:

- A computer
- An RJ-11 telephone cable (optional). Two RJ-11 telephone cables are required if your service provider has supplied you with two telephone numbers.

Easy Setup

The CPE is easily set up in your home. Basic installation equipment needed are the power adapter and cord, Ethernet cable, a PC or laptop computer and the CPE device. If you want to use the VoIP functionality, you need an RJ-11 phone cable and a telephone.

Perform the following tasks before attaching the power cord or powering up the unit:

- Stand the CPE on a flat surface.
- Plug the power adapter into the power connector on the back of the unit.
- Plug the AC power cord into an AC outlet.
- Plug one end of the Ethernet cable into the Ethernet connector on the back of the unit.
- Plug the other end of the Ethernet cable into the Ethernet connector of your computer.
- To use VoIP functionality of the phone, plug one end of the phone line into the activated phone connector on the back of the unit. Phone line activation is dependent upon your service contract.
- Plug the other end of the phone line into the phone line connector of your telephone.

Advanced Setup

The CPE can also be used to connect to a multi-port switch (hub) - purchased separately from the CPE. Connecting the CPE device to a hub allows you to connect more than one computer to your CPE device.

Procedure to Log into the CPE

Before you Begin Configuration

Some settings on your computer need to be verified or changed to ensure that your computer configuration can support the Desktop CPE.

Verify that the IP addresses and DNS settings are automatically generated in your Local Area connection of your Internet Protocol (TCP/IP) properties. Refer to the chapter titled "Configuring TCP/IP" for additional information.

Logging in to the CPE

Use the following procedure to log into the Desktop CPE:

1. On a computer that is connected to the Desktop CPE, open a web browser.
2. In the Address or Location field, type **http://mywimax.** and press **ENTER** to display the login screen.
Include the period (.) after `http://mywimax.` in order to access the login screen.



Enter the IP address: `http://192.168.15.1` into Address field in order to gain access to your CPE. If you cannot access the CPE, refer to the chapter titled: Configuring TCP/IP for more information.

3. The Welcome to Motorola WiMAX CPE screen is displayed and prompts you for a password.

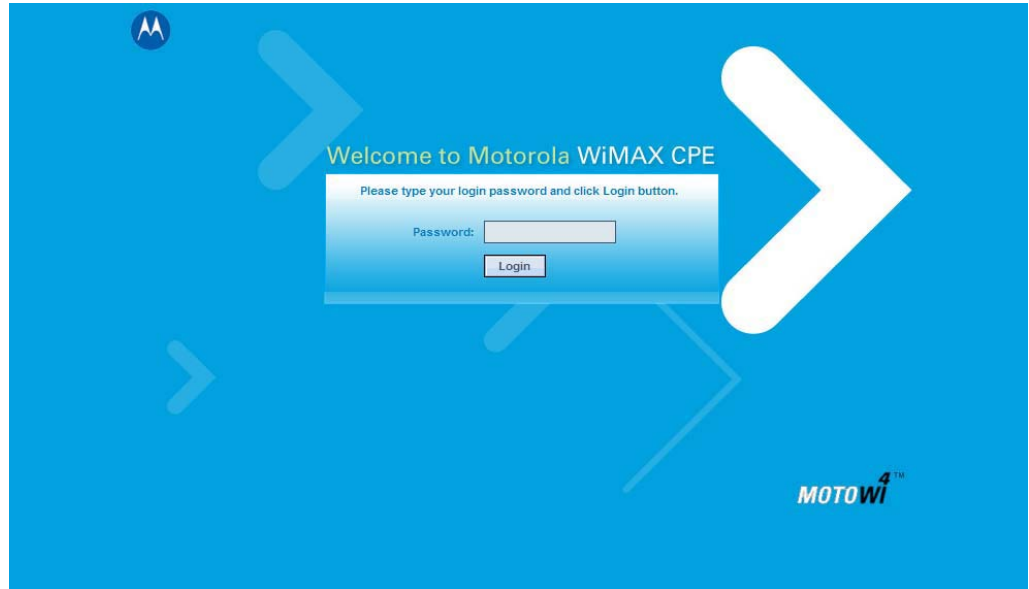
Figure 2-1: Login Screen

4. In the **Password** field, type the password (default is **motorola**).
5. Click **Login**.
6. First time users see a pop-up box that states: "The Wizard application will guide you through for the first time configuration". Click **OK** button to continue.
7. Click the **OK** button to launch the wizard application.

Setup Wizard and Authentication

Step 1 - Change Password

Once you have launched the setup wizard, you are prompted to change your password. Motorola recommends using a password to protect your home network and CPE device. Passwords are case sensitive.

To change your password:

- Ensure the "Enable Login Password Protection" box is checked.
- Enter a New Login Password in the box. Passwords can be no more than 20 characters in length.
- Re-type your new password in the Confirm New Login Password box.
- Click **Next**.

If you forget your password, you can reset it back to the default (motorola) password. To reset the password, press and hold the reset button on the back of your CPE for 5 or more seconds. Before resetting the CPE, ensure that the power is ON.

Step 2 - Device Time

This screen allows you to set the time zone and to enable Daylight Savings Time (when applicable) for your location.

- Select the appropriate time zone for your location from the drop-down box.

- Check the box that is called “Auto Adjust for Daylight Savings Time” if you live in a region that observes Daylight Savings Time. This box is checked by default.
- Click the **Next** button.

Step 3 - WiMAX Security

The WiMAX Security tab contains your authentication method. Check with your service provider to determine if they require a user name and password for authentication purposes.

- If the Authentication Method is EAP-TLS, no User Name and Password are required. Enter the Realm information supplied by your service provider. Click the **Next** button.
- If the Authentication Method is EAP-TTLS/MS-CHAPv2, enter a User Name and Password, and Realm information supplied by your Service Provider. Once you have entered the User Name/Password/Realm information, click the **Next** button.
- If you are unsure of the Authentication Method, select EAP-TLS (which is the default) and click the **Next** button.

Step 4 - Account

The Account tab allows you to manage Voice over IP (VoIP) related services. Please consult with your telephony service provider for these settings.

Click the **Apply** button when finished.

Congratulations! You have now completed the setup of your WiMAX connection.

Click **OK** on the Congratulations! dialog box.

A status screen appears that shows Network status and telephony status. The Network Status screen provides any status associated with your WiMAX Wireless Broadband connection. The Telephony Status screen provides status of your telephony service.

- The **Restart** button is used to restart the device. The restart button is available on every screen.
- The **Wizard** button starts the set-up wizard over again.
- The **Refresh** button refreshes the screen with the current status.
- The **Auto Refresh** button allows the web browser to automatically refresh at the interval determined in the Control Panel menu.

Figure 2-2: Status Screen



Restart Button

Figure 2-3: Restart Button



Chapter 3: Basic Configuration

Once the CPE setup has been completed, you can log in to your CPE from any computer on your home network. To log in type the device name in the address bar on your computer. The default device name is mywimax.

This section describes the PERSONALIZE, INTERNET, and STATUS Menus that are available.

Personalize Menu

The Personalize menu provides the following tabs:

- Password
- Device Time
- Device Name
- Restore Factory Settings

Figure 3-1: Personalize Menu

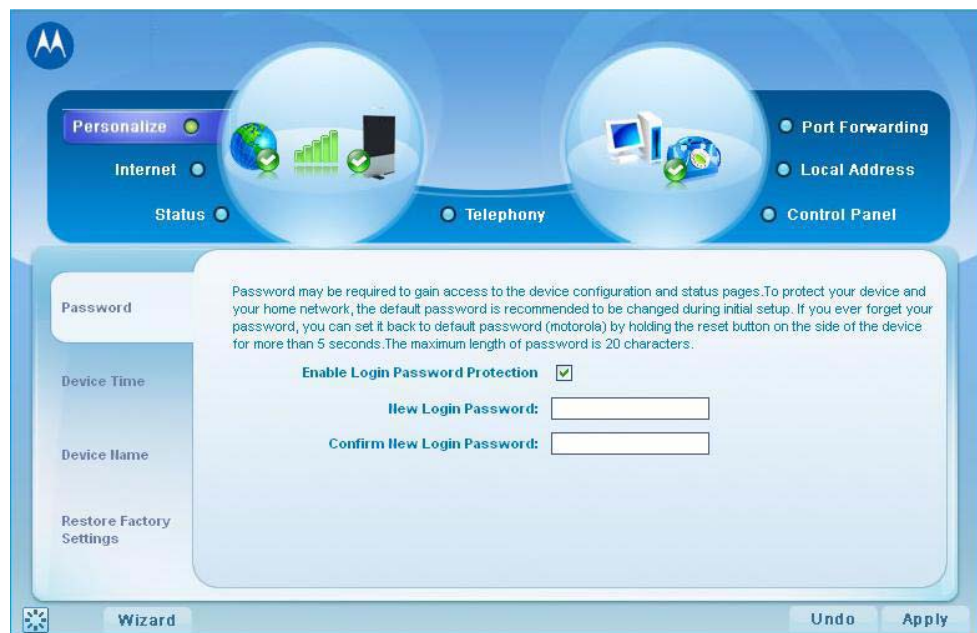

Password Tab

The password tab allows you to enable/disable password protection. You can also change your password here. Be sure to click the **Apply** button when finished

Table 3-1 Password Tab

Field or Button	Description
Enable Login Password Protection	Checking this box requires login password protection.
New Login Password	Enter your new password here. Maximum 20 characters. Passwords are case sensitive.
Confirm New Login Password	Re-enter your new password here, exactly as entered in the previous step.

Device Time Tab

The Device Time tab allows you to establish the time zone for your location. It also allows you to automatically adjust for Daylight Savings Time if necessary. Be sure to click the **Apply** button when finished.

Table 3-2 Device Time Tab

Field or Button	Description
Current Local Time	Current Local Time
Time Zone	Select your local time zone from the drop-down box.
Auto Adjust for Daylight Saving Time	Check this box if your location observes Daylight Savings Time. (Default is checked)

Device Name Tab

The Device Name tab allows you to rename your CPE device. The Device Name is the name you enter on an internet browser address bar to access your CPE device. Be sure to click the **Apply** button when finished.

Table 3-3 Device Name Tab

Field or Button	Description
New Device Name	Enter the new name for the CPE device. Maximum 20 characters.

Restore Factory Settings Tab

The Restore Factory Settings Tab resets your CPE to the manufacturers default settings. Be sure to click the **Apply** button if you are sure that you want to reset factory settings.

Table 3-4 Restore Factory Settings Tab

Field or Button	Description
Restore Factory Settings	Checking this box restores the CPE to factory default settings. The device restarts when you click Apply .

Internet Menu

The Internet menu provides the following tabs:

- WiMAX Security
- Internet Protocol
- Firewall
- Dynamic DNS

Figure 3-2: Internet Menu

Personalize Internet Status Telephony Port Forwarding Local Address Control Panel

WIMAX Security

Some Internet Service Provider may require user name and password for authentication purposes. Please consult with service provider for these settings. If not sure, leave them with default value.

Authentication Method:

User Name:

Password:

Password Confirmation:

Realm:

Wizard

WiMAX Security Tab

The WiMAX Security tab contains your authentication method. Check with your service provider to determine a user name and password are required for authentication purposes.

Table 3-5 WiMAX Security Tab

Field or Button	Description
Authentication Method	Drop down box allows you to select either EAP-TLS (default) or EAP-TTLS/MS-CHAPv2.
User Name (EAP-TTLS/MS-CHAPv2 only)	Enter the User Name supplied by your service provider.
Password (EAP-TTLS/MS-CHAPv2 only)	Enter the Password supplied by your service provider.
Realm	Supplied by your service provider.

If your authentication method is EAP-TLS, then a User Name and Password are not necessary.

Click the **Apply** button.

Internet Protocol Tab

Please check with your service provider for these settings. If you are unsure of the settings, leave the default values set and click the **Apply** button.

If your service provider has instructed you to change any of these settings, be sure to click the **Apply** button when you are finished.

Firewall Tab

A firewall helps to protect your home network from unauthorized access. It also helps to manage authorized access from the internet to your CPE.

Table 3-6 Firewall Tab

Field or Button	Description
Enable Firewall	Check this box to enable the firewall for your home network.
Enable Web Login from Internet	(Grayed out if Enable Firewall is not selected). Check this box to enables you to access your CPE device from a network other than your own.
Web Login Port from Internet	Choose a port number to connect to when logging in from a network other than your own. The default is 8080.

Table 3-6 Firewall Tab

Field or Button	Description
	the Internet. This option would be enabled to allow testing only. Do not leave this enabled.

Be sure to click the **Apply** button once you are finished.

Dynamic DNS Tab

Dynamic Domain Name Service (DDNS) allows a user with a non-static IP address to keep their domain name associated with an ever changing IP address. As an example, DDNS is used when you are hosting your own website.

Table 3-7 Dynamic DNS Tab

Field or Button	Description
Enable DDNS	Check this box to Enable DDNS (default is unchecked).
DDNS Service Provider	Select DDNS Service Provider that you belong to from the drop-down box.
DDNS User Name	Only valid if Enable DDNS is checked. Enter your DDNS account user name.
DDNS Password	Only valid if Enable DDNS is checked. Enter your DDNS account password.
DDNS Host Name	Only valid if Enable DDNS is checked. Enter the DDNS Host Name. This is assigned by the DDNS service.

Be sure to click the **Apply** button once you are finished.

Status Menu

The Status menu provides the following tabs:

- Network
- Telephony

Figure 3-3: Status Menu

Network Tab

The Network tab provides any status associated with your WiMAX Wireless Broadband connection.

Telephony Tab

The Telephony tab provides any status associated with your telephony connection.

Telephony Menu

The telephony menu allows you to manage your Voice over Internet Protocol (VoIP) services.



NOTE

Contact your service provider to obtain VoIP service, if you do not already have this service.

The Telephony menu provides the following tabs:

- Account
- Ring Tone
- Caller ID
- Call Forwarding
- Voice Mail
- Special Numbers

Figure 3-4: Telephony Menu

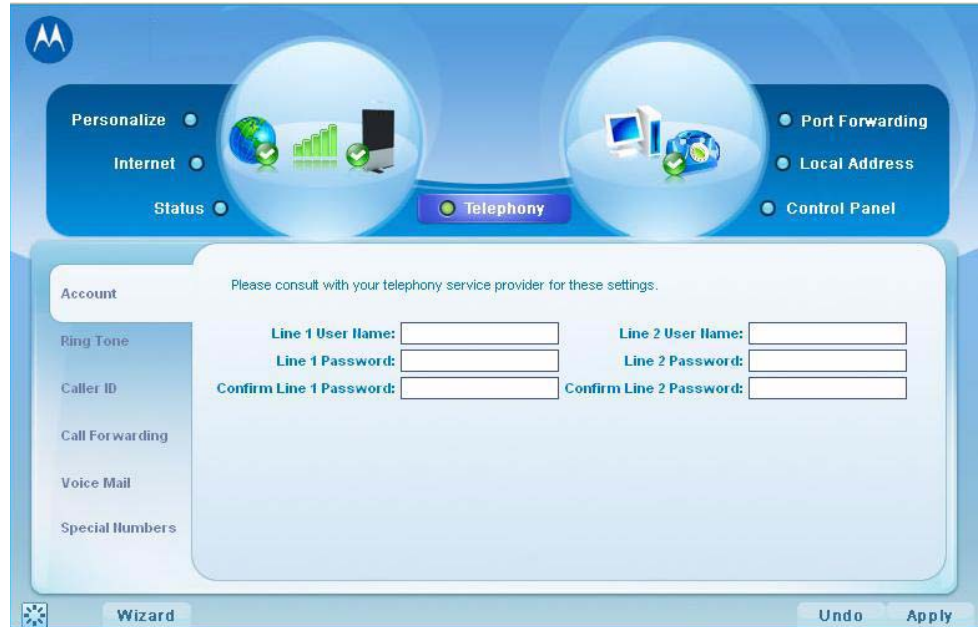

Account Tab

Please consult with your service provider for these settings. The Account Tab contains the following settings:

Table 3-8 Account Tab

Field or Button	Description
Line 1 User Name	If Line 1 is an active VoIP, enter the User Name as provided by your service provider.
Line 1 Password	Enter the Line 1 password as provided by your service provider. Passwords are case sensitive.
Confirm Line 1 Password	Reenter your Line 1 password exactly as entered in the field from the previous step.
Line 2 User Name	If Line 2 is an active VoIP, enter the User Name as provided by your service provider.
Line 2 Password	Enter the Line 2 password as provided by your service provider. Passwords are case sensitive.
Confirm Line 2 Password	Re-enter your Line 2 password exactly as entered in the field from the previous step.
<u>Be sure to click the Apply button once you have made changes.</u>	

Ring Tone Tab

The Ring Tone tab allows you to customize ring tones for your telephone(s).



NOTE

you need a phone connected to your CPE to hear ring tones.

Table 3-9 Ring Tone Tab

Field or Button	Description
Default Line 1 Ring Type	Use the drop-down box to select a ring tone for Line 1. The default is ringtone R0.
Test	Click to hear how the selected ring tone sounds.
Default Line 2 Ring Type	Use the drop-down box to select a ring tone for Line 2. The default is ringtone R0.
Test	Click to hear how the selected ring tone sounds.

Be sure to click the **Apply** button once you have made changes.

Caller ID Tab

The Caller ID tab allows you to manage the Caller ID functions for your telephones:

Table 3-10 Caller ID Tab

Field or Button	Description
Enable Line 1 Anonymous Incoming Call Rejection	If Line 1 is your active telephone port, check this box if you would like to reject telephone calls from anonymous incoming callers. The default is checked.
Enable Line 1 Permanent Anonymous Outgoing Call	If Line 1 is your active telephone port, check this box if you would like to permanently block your telephone number from appearing on others' Caller ID. The default is unchecked.
Enable Line 2 Anonymous Incoming Call Rejection	If Line 2 is your active telephone port, check this box if you would like to reject telephone calls from anonymous incoming callers. The default is checked.

Table 3-10 Caller ID Tab

Field or Button	Description
Outgoing Call	check this box if you would like to permanently block your telephone number from appearing on others' Caller ID. The default is unchecked.

Be sure to click the **Apply** button once you have made changes.

Call Forwarding Tab

The Call Forwarding tab allows you to manage the call forwarding features for your telephone(s). The Call Forwarding tab contains the following:

Table 3-11 Call Forwarding Tab

Field or Button	Description
Enable Line 1 Basic Forwarding	Check this box to enable basic call forwarding on Line 1. The default is unchecked.
<u>Line 1 Basic Forwarding to Number</u>	If "Enable Line 1 Basic Forwarding" is checked, enter the telephone number you would like to forward calls to.
<u>Enable Line 1 Forwarding on No Answer</u>	Check this box to forward calls received on Line 1 if there is no answer. This function is not available if "Enable Line 1 Basic Forwarding" is checked.
<u>Line 1 No Answer Forwarding to Number</u>	If "Line 1 No Answer Forwarding to Number" is checked, enter the telephone number you would like to forward calls to when there is no answer on Line 1. This function is not available if "Enable Line 1 Basic Forwarding" is checked.
<u>Line 1 No Answer Forwarding Ring Count</u>	Enter the number of rings allowed before the call forwards to the number identified above. The default is six rings.
<u>Enable Line 1 Forwarding on Busy</u>	Check this box to forward calls received while Line 1 is in use.
<u>Line 1 Busy Forwarding To Number</u>	If "Enable Line 1 Forwarding on Busy" is checked, enter the telephone number you would like calls forwarded to when Line 1 is in use.
<u>Enable Line 2 Basic Forwarding</u>	Check this box to enable basic call forwarding on Line 2. The default is unchecked.
<u>Line 2 Basic Forwarding to Number</u>	If "Enable Line 2 Basic Forwarding" is checked, enter the telephone number you would like to forward calls to.

Table 3-11 Call Forwarding Tab

Field or Button	Description
	on Line 2 if there is no answer. This function is not available if "Enable Line 2 Basic Forwarding" is checked.
<u>Line 2 No Answer Forwarding to Number</u>	If " <u>Line 2 No Answer Forwarding to Number</u> " is checked, enter the telephone number you would like to forward calls to when there is no answer on Line 2. This function is not available if "Enable Line 2 Basic Forwarding" is checked.
<u>Line 2 No Answer Forwarding Ring Count</u>	Enter the <u>number of rings</u> allowed before the call forwards to the number identified above. The default is six rings.
<u>Enable Line 2 Forwarding on Busy</u>	Check this box to forward calls received while Line 2 is in use.
<u>Line 2 Busy Forwarding To Number</u>	If " <u>Enable Line 2 Forwarding on Busy</u> " is checked, enter the telephone number you would like calls forwarded to when Line 2 is in use.

Be sure to click the **Apply** button once you have made changes.

Voice Mail Tab

The voice mail tab allows you to see the status of your voice mail.

Please contact your service provider to activate the voice mail feature if it is not already active. The Voice Mail Tab contains the following:

Table 3-12 Voice Mail Tab

Field or Button	Description
<u>Line 1 Server Based Voice Mail Status</u>	Shows the status of Line 1 voice mail as either enabled or disabled.
<u>Line 1 Number of New Voice Mails</u>	Shows the <u>number of new, unheard voice mails</u> on Line 1.
<u>Line 1 Number of Old Voice Mails</u>	Shows the <u>number of previously heard voice mails</u> on Line 1.
<u>Line 2 Server Based Voice Mail Status</u>	Shows the status of Line 2 voice mail as either enabled or disabled.
<u>Line 2 Number of New Voice Mails</u>	Shows the <u>number of new, unheard voice mails</u> on Line 2.
<u>Line 2 Number of Old Voice Mails</u>	Shows the <u>number of previously heard voice mails</u> on Line 2.

Be sure to click the **Apply** button once you have made changes.

Special Number Tab

The Special Number tab provides a list of special dialing numbers for your VoIP Phone Service. The Special Number Tab contains the following:

Table 3-13 Special Number Tab

Field or Button	Description
Service Provider Contact Number	Use this number to contact customer service for your service provider.
Emergency Number	Dial this number to reach local emergency services.
Redial	Dial this number to redial the last number called.
Blind Call Transfer	Dial this number to transfer a call directly to a third party.
Consultation Call Transfer	Dial this number to speak with the third party before you transfer the call to them.
Call Hold	Dial this number to place your current call on hold.
Automatic Recall Activate	Dial this number to call back the number of the last incoming call.
Automatic Recall Deactivate	Dial this number to automatically call back the last number dialed when that number becomes available.
Call Forwarding Activate	Dial this number to forward your calls to a different number.
Call Forwarding Deactivate	Dial this number to deactivate call forwarding.
Call Forwarding Busy Activate	Dial this number to forward calls to a different number when the line is busy.
Call Forwarding Busy Deactivate	Dial this number to de-activate calls from forwarding to a different number when the line is busy.
Call Forwarding Busy Change Number	Dial this number to change the phone number to which calls will be forwarded when the line is busy.
Call Forwarding No Answer Activate	Dial this number to forward calls to a different number when there is no answer on Line 1 or Line 2.
Call Forwarding No Answer Deactivate	Dial this number to de-activate calls from forwarding to a different number when there is no answer on Line 1 or Line 2.
Call Forwarding No Answer Change Number	Dial this number to change the phone number to which calls will be forwarded when there is no answer on Line 1 or Line 2.

Table 3-13 Special Number Tab

Field or Button	Description
	call you missed and to return the call. If the number is busy, you can hang up. When the number is available, your phone will ring. Pick up your phone and the call will be connected.
<u>Automatic Callback Deactivate</u>	Dial this number to de-activate automatic callback.
<u>Do Not Disturb Activate</u>	Dial this number to have calls automatically routed to voice mail.
<u>Do Not Disturb Deactivate</u>	Dial this number to cancel automatic call routing to voice mail.
<u>Calling Number Delivery Blocking</u>	Dial this number to block your number from appearing on the Caller ID of the people you call. Your calls may appear as "Private" or "Anonymous".
<u>Line Blocking Deactivate</u>	Dial this number to unblock your telephone number from appearing on Caller ID.
<u>Call Waiting Toggle</u>	Dial this number to toggle between call waiting ON and call waiting OFF.
<u>Anonymous Call Rejection Activate</u>	Dial this number to have anonymous calls rejected.
<u>Anonymous Call Rejection Deactivate</u>	Dial this number to allow anonymous calls to go through.

Chapter 4: Advanced Configuration

The Advanced Configuration section describes the Port Forwarding, Local Address, and Control Panel menus.

Port Forwarding Menu

Port forwarding enables you to direct incoming traffic to specific LAN hosts (computers on your network) based on the protocol and port number. It is used to play Internet games or provide local services (such as web hosting) for a LAN group. The Port Forwarding menu provides the following tabs:

- Basic
- Forwarding

Figure 4-1: Port Forwarding

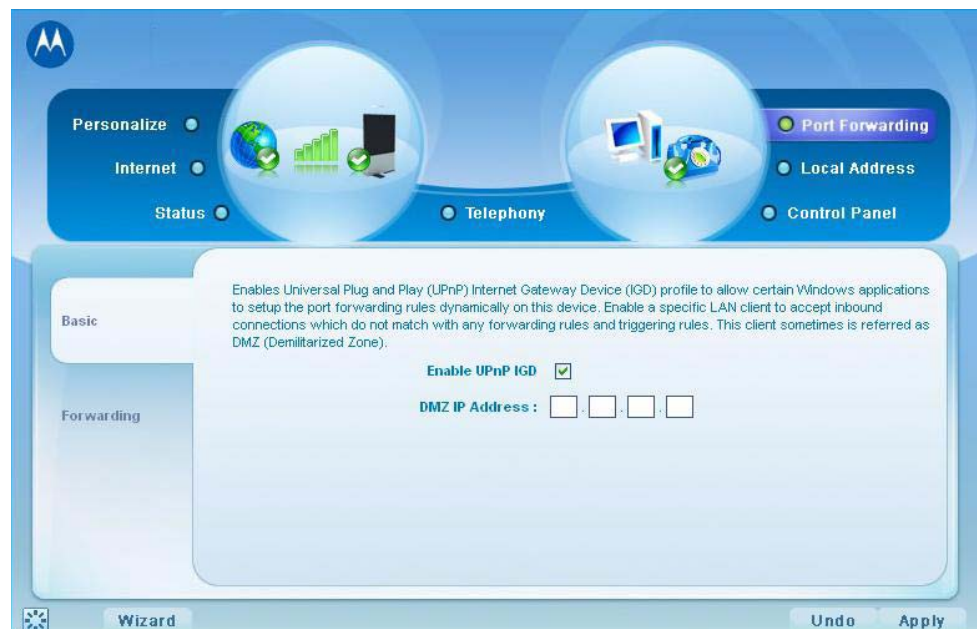

Table 4-1 Port Forwarding Menu

Field or Button	Description
Enable UPnP IGD	Enables the Universal Plug and Play (UPnP) Internet Gateway Device (IGD) profile to allow certain Windows applications to set up the port forwarding rule dynamically when NAT is enabled on this device.
DMZ (DeMilitarized Zone) IP Address	Enter the DMZ IP Address.

Be sure to click the **Apply** button once you have made changes.

Forwarding Tab

Click the **ADD** button to create additional Port Forwarding rules. The Forwarding tab contains the following selections:

Table 4-2 Forwarding Tab

Field or Button	Description
Select	Select a box when you want to delete the specific row.
Protocol	Select TCP (Transmission Control Protocol) or UDP (User Datagram Protocol).
WAN Port Start	Enter the beginning port range for external network access.
WAN Port End	Enter the ending port range for external network access.
LAN IP Address	Enter the IP address to host the service.
LAN Port Start	Enter the beginning port range for internal network access.
LAN Port End	Enter the ending port range for internal network access.
Enabled	Check to enable specific port forwarding.

Be sure to click the **Apply** button once you have made changes.

Local Address Menu

The Local Address menu allows you to configure your Local Area Network (LAN) connections.

The Local Address menu provides the following tabs:

- DHCP Server
- Lease Status
- Lease Reservation

Figure 4-2: Local Address Menu



DHCP Server Tab

The DHCP Server tab enables Dynamic Host Configuration Protocol (DHCP) server functionality on the LAN, allowing the router to dynamically assign lease IP addresses to clients that connect to it from the local network. The DHCP Server Tab contains the following selections:

Table 4-3 DHCP Server Tab

Field or Button	Description
Enable DHCP Server	If selected, the DHCP server on the gateway assigns IP addresses to the computers and other hosts on your network if they have DHCP enabled. By default, the gateway server is enabled. If there is another DHCP server running on your network (on another router), disable one of the DHCP servers.
DHCP Server IP Address	Enter the default port forwarding LAN Client IP Address.
DHCP Starting IP Address	Sets the first IP address assigned by the DHCP server, in dotted-decimal format. It must be greater than the IP address value of the gateway. For example, if the IP address of the gateway is 192.168.15.1 (default), the starting IP address must be 192.168.15.2 (or higher).

Table 4-3 DHCP Server Tab

Field or Button	Description
	DHCP server. If the DHCP server runs out of DHCP addresses, users cannot access network resources. If this happens, increase the Ending IP or reduce the Lease Time.
DHCP Lease Time	Sets the time, in seconds, that a network computer remains connected to the gateway using its current assigned IP address. At the end of this time, the DHCP server renews the lease or assigns the computer a new IP address. The default is 3600 seconds (one hour). The maximum is 999999 seconds (about 278 hours).

Be sure to click the **Apply** button once you have made changes.

Lease Status Tab

The Lease Status tab in the Local Address menu displays the active DHCP leases since the last reboot. The Lease Status Tab contains the following selections:

Table 4-4 Lease Status Tab

Field or Button	Description
Client Host Name	Displays the client host name. The Name field is limited to 20 characters (only 5 appear in display).
MAC Address	Media Access Control (MAC) address.
IP Address	Shows the IP Address for each active lease.
Remaining Lease Duration	Shows the amount of time, in seconds, remaining in the lease.

Be sure to click the **Apply** button once you have made changes.

Lease Reservation Tab

This tab allows you to manage the lease reservation so that the same client receives the same IP address each time. The Lease Reservation Tab contains the following selections:

Table 4-5 Lease Reservation Tab

Field or Button	Description
Select	Select this box if you want to delete an established lease reservation. Be sure to click the Delete button once you have selected the exception to be deleted.
Client Host Name	Enter the client host name. The Name field is limited to 20 characters (only 5 appear in display)
MAC Address	Media Access Control (MAC) address. Enter the MAC address of the device.
IP Address	Enter the IP address that you want assigned to the MAC Address.
Enabled	Clicking this box enables the lease reservation.

Be sure to click the **Apply** button once you have made changes.

Control Panel

The Control Panel sections allows you to view/update your software information.

The Control menu provides the following tabs:

- Software
- Certificate
- System
- About

Figure 4-3: Control Panel Menu

Software Tab

The Software tab manages the software on your CPE device. It is also where you can upgrade device software.

Use the **BROWSE** button to browse your computer for additional software packages. Once you have located the software package/update you would like to add to your device, click the **Upgrade** button.

You should see the available software updates in the “Available Software Packages” table. If you cannot see the list, click the **View** button.

Select the software you would like to install and click the **Install** button.

If you would like to remove software, select the software package you would like to remove and click **Uninstall**.

Certificate Tab

The Certificate tab is where you manage the certificates that are stored on the device.

Use the **BROWSE** button to locate the certificate file on your computer, and then click the **IMPORT** button.

Use the **REMOVE** button to remove any selected certificate(s).

System Tab

This tab allows you to manage additional features of your CPE device

Table 4-6 System Tab

Field or Button	Description
Language Used in User Interface	Select the desired language for the user interface. The default language is English.
Enable WiMAX Radio Interface	Check this box to enable the WiMAX Radio Interface.
Enable LED	Check this box to enable the LEDs on the front of your CPE device.
Auto Refresh Interval	Enter, in seconds, the interval for status Auto Refresh. Valid range is 2 seconds - 9999 seconds. The default value is 3 seconds.
Rebootstrap EMS	Check this box to reconnect the device with the EMS. Only perform this function under the supervision of a Customer Support Representative.

About Tab

The About Tab displays basic properties of your CPE device such as: Product Name, Model ID, Hardware Version, Serial Number, and the WiMAX MAC Address.

Chapter 5: Configuring TCP/IP

This section contains two examples of configuring TCP/IP in a Windows environment. Most computers already have the TCP/IP configuration enabled. Use the following procedures to verify that the configuration is set up. Configure all client computers on your network for TCP/IP (the protocol that controls communication among computers). Two examples are provided in this document:

- Configuring TCP/IP in Windows 2000
- Configuring TCP/IP in Windows XP



NOTE

Follow the instructions in your computer user manual for other Operating Systems.

Configuring TCP/IP in Windows 2000

1. On the Windows Desktop, click **Start**.
2. Select **Settings** and then **Control Panel** from the pop-up menus to display the Control Panel window:

Figure 5-1: Windows Control Panel

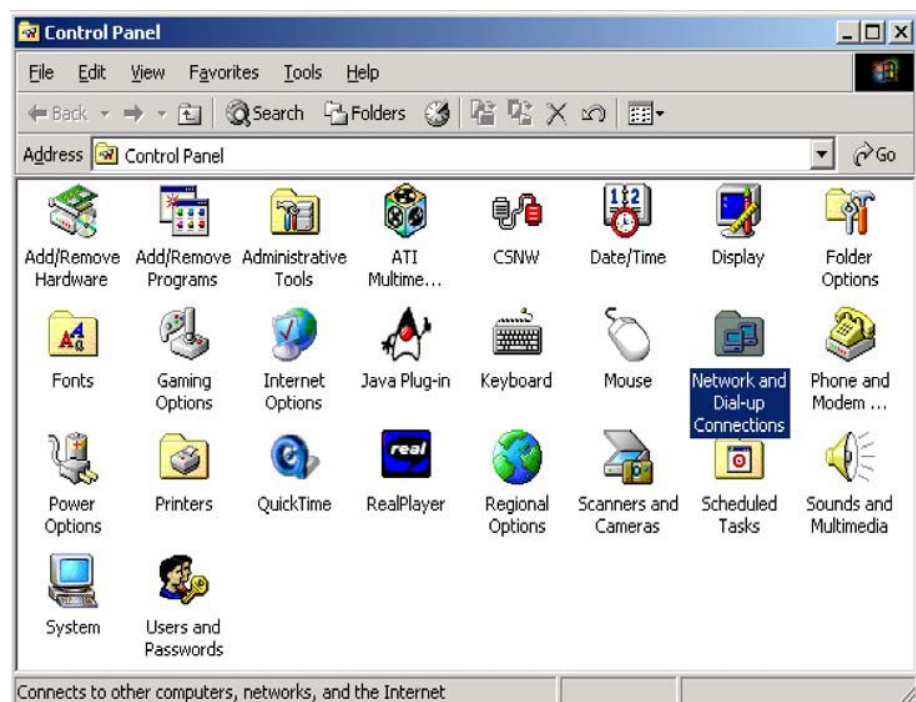

3. Double-click the **Network and Dial-up Connections** icon to display the Network and Dial-up Connections window:

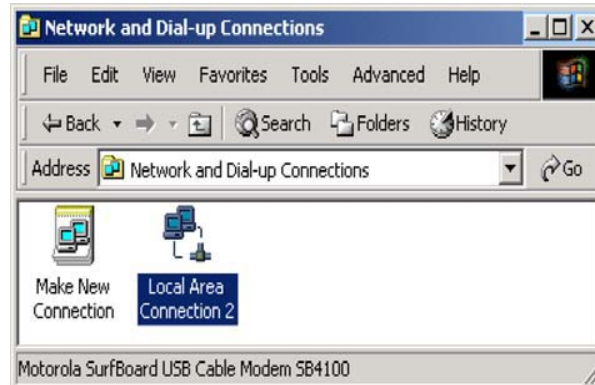
Figure 5-2: Network and Dial-up Connections

In the steps that follow, a connection number like 1, 2, 3, etc., is a reference that is displayed on computers with multiple network interfaces. Computers with only one network interface may only see the label: Local Area Connection.

4. Click **Local Area Connection** number. The value of number varies from system to system. The Local Area Connection number Status window is displayed:

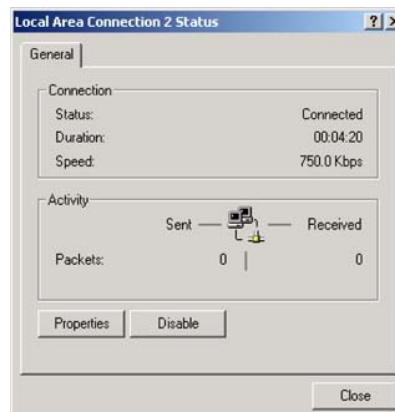
Figure 5-3: Local Area Connection

5. Click **Properties**. Information like the following window is displayed:

Figure 5-4: Properties

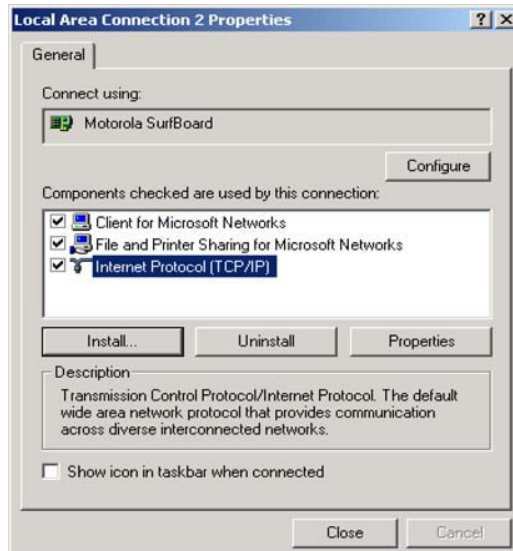

6. If Internet Protocol (TCP/IP) is in the list of components, TCP/IP is installed. You can skip to Step 10.

Figure 5-5: Select Network Connection Type

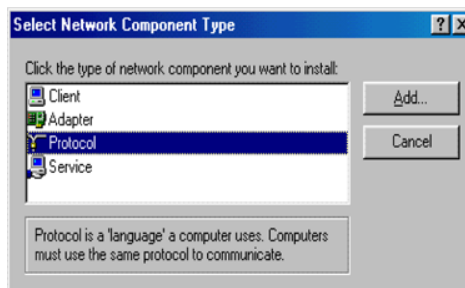

If Internet Protocol (TCP/IP) is not in the list, click **Install**. The Select Network Component Type window is displayed:

7. Click **Protocol** on the Select Network Component Type window and click **Add**. The Select Network Protocol window is displayed:

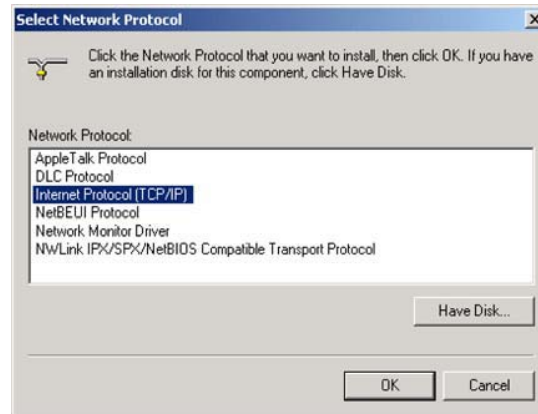
Figure 5-6: Select Network Protocol**NOTE**

you might have to use the scroll bar to locate the Internet Protocol (TCP/IP) setting.

8. Click **Internet Protocol (TCP/IP)**.
9. Click **OK**. The Local Area Connection number Properties window is re-displayed.
10. Be sure the box next to Internet Protocol (TCP/IP) is checked.
11. Click **Properties**. The Internet Protocol (TCP/IP) Properties window is displayed:

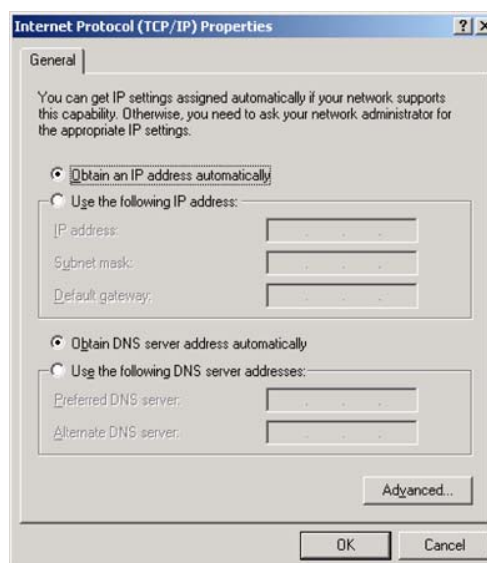
Figure 5-7: Internet Protocol (TCP/IP) Properties

12. Be sure Obtain IP address automatically and Obtain DNS server address automatically are selected.

13. Click OK to accept the TCP/IP settings.
14. Click Close to close the Local Area Connection number Properties window.
15. Click **OK**.
16. If prompted to restart the computer and click OK again.

Configuring TCP/IP in Windows XP

1. On the Windows desktop, click **Start** to display the Start window:

Figure 5-8: Windows XP Start Window



2. Click **Control Panel** to display the Control panel window. The display varies, depending on your Windows XP view options. If the display is a Category view as shown in Figure 5-9, continue with Step 3. Otherwise, skip to Step 5.

Figure 5-9: Control Panel

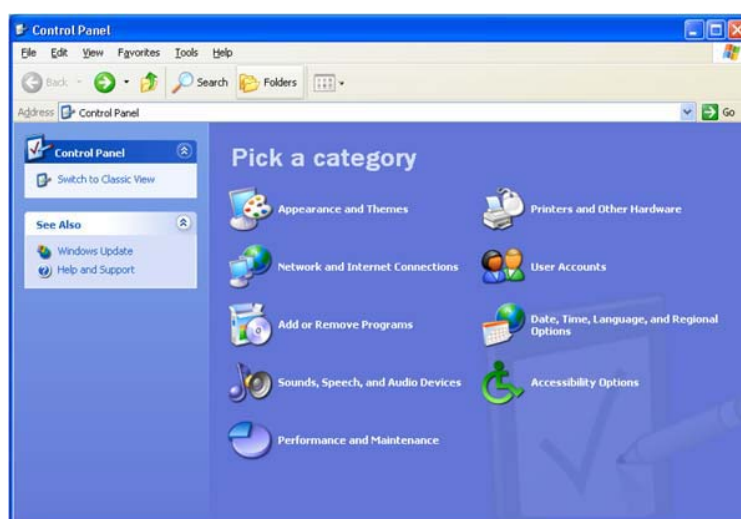

3. Click **Network and Internet Connections** to display the Network and Internet Connections window:

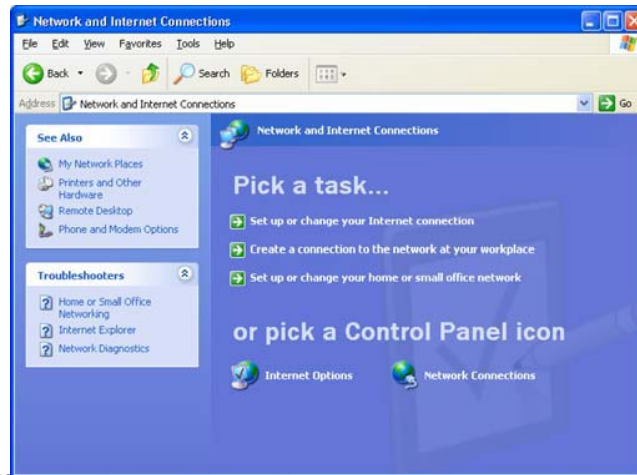
Figure 5-10: Network and Internet Connections

4. Click **Network Connections**. Skip to Step 6.
5. If a classic view like Figure 5-11 is displayed, double-click **Network Connections** to display the LAN or High-speed Internet connections.

Figure 5-11: Control Panel Classic View

6. Right-click the **Local Area Connection**. If more than one connection is displayed, be sure to select the one for your network interface.

Figure 5-12: Network Connections

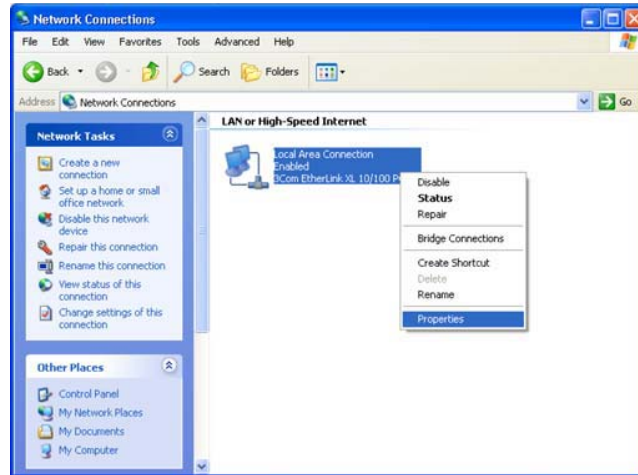

7. Select **Properties** from the pop-up menu to display the Local Area Connection Properties window:

Figure 5-13: Local Area Connection Properties

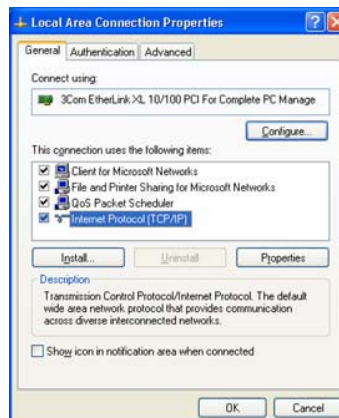

8. On the Local Area Connection Properties window, select **Internet Protocol (TCP/IP)** if it is not selected.
9. Click **Properties** to display the Internet Protocol (TCP/IP) Properties window.

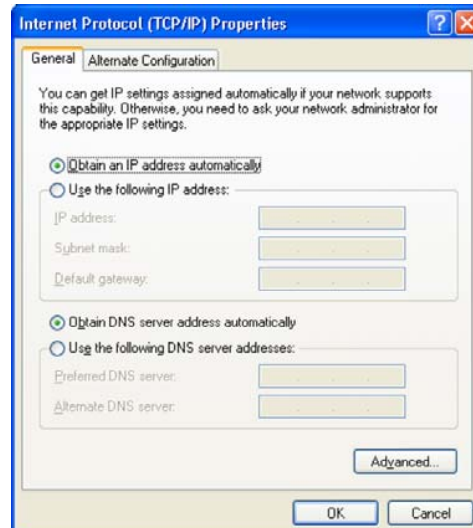
Figure 5-14: Internet Protocol (TCP/IP) Properties

10. Be sure Obtain IP address automatically and Obtain DNS server address automatically are selected.
11. Click **OK** to close the TCP/IP Properties window.

Chapter 6: Troubleshooting

Power

- Check that the AC power adapter is properly plugged into the electrical outlet and into the Desktop CPE.
- Check that the electrical outlet is working.

A Computer Cannot Log On to the CPE

Check that the Ethernet cable is properly connected to the Desktop CPE unit and the computer.

Cannot Connect to the Internet

- Check the Desktop CPE connection status from the Web Interface, refer to the Connection Status section to verify the connection status.
- If the Desktop CPE connection is down, and the gateway has not received an IP for 5 minutes to 10 minutes:
 - Re-Run the Setup Wizard.
 - If the Setup Wizard does not help, then reset the Desktop CPE using the reset button.

Additional Troubleshooting Help

Contact your service provider for additional help.

Chapter 7: Important Safety and Legal Information

Your Motorola WiMAX Wireless Broadband Gateway is designed and tested to comply with a number of national and international standards and guidelines (listed below) regarding human exposure to RF electromagnetic energy.

This Product complies with the following RF energy exposure standards and guidelines:

- United States Federal Communications Commission, Code of Federal Regulations; 47CFR part 2 sub-part J
- American National Standards Institute (ANSI)/ Institute of Electrical and Electronic Engineers (IEEE) C95 1-2005
- Institute of Electrical and Electronic Engineers (IEEE) C95.1-1999 Edition
- International Commission on Non-Ionizing Radiation Protection (ICNIRP) 1998
- Ministry of Health (Canada) Safety Code 6. Limits of Human Exposure to Radio frequency Electromagnetic Fields in the Frequency Range from 3 kHz to 300 GHz, 1999
- Australian Communications Authority Radiocommunications (Electromagnetic Radiation - Human Exposure) Standard, 2003
- ANATEL ANNEX to Resolution No. 303 of July 2, 2002 "Regulation of Limitation of Exposure to Electrical, Magnetic, and Electromagnetic Fields in the Radio Frequency Range Between 9 kHz and 300 GHz" and "Attachment to Resolution #303 from July 2, 2002"

RF Exposure Compliance and Guidelines Operating Instructions

To comply with FCC RF energy exposure requirements, this Gateway desktop transmitter should be operated at a minimum separation distance of 20 cm from all persons.

For additional information on exposure requirements or other training information, visit <http://www.motorola.com/rfhealth>

FCC Regulatory Information

The 2.5GHz WiMAX device (Model Name: CPEi25725) complies with Part 15 of the FCC Rules. Operation is subject to the following two conditions: (1) this device may not cause harmful interference, and (2) this device must accept any interference received; including interference that may cause undesired operation.

This equipment has been tested and found to comply with the limits for a Class B digital device pursuant to Part 15 of the FCC rules. These limits are designed to provide reasonable protection against harmful interference in a residential installation. This equipment generates, uses, and can radiate radio frequency energy and, if not installed and used in accordance with the instructions, may cause harmful interference to radio communications. However there is no guarantee that interference will not occur in a particular installation, which can be determined by turning the equipment off and on, the user is encouraged to try to connect the interference by one of the following measures:

- Reorient or relocate the receiving antenna.
- Increase the separation between the equipment and receiver.

- Connect the equipment into an outlet on a circuit different from that to which the receiver is connected.
- Consult the dealer or an experienced radio/TV technician for help.

This Gateway desktop transmitter must not be co-located or operating in conjunction with any other antenna or transmitter.

FCC Caution: Any changes or modifications not expressly approved by the party responsible for compliance could void the user's authority to operate this equipment.

Industry Canada Statement

2.5GHz WiMAX device (Model Name: CPEi25725) complied with RSS-Gen and RSS-193 of the Industry Canada Rules.

Operation is subject to the following two conditions:

- This device may not cause interference and
- This device must accept any interference, including interference that may cause undesired operation of the device.

This device has been designed to operate with an antenna having a maximum gain of 5 dBi. Antenna having a higher gain is strictly prohibited per regulations of Industry Canada. The required antenna impedance is 50 ohms. To reduce potential radio interference to other users, the antenna type and its gain should be so chosen that the equivalent isotropically radiated power (E.I.R.P) is not more than that permitted for successful communications.

This Class B digital apparatus complies with Canadian ICES-003.

Cet appareil numérique de la class B est conforme à la norme NMB-003 du Canada.

Radiation Exposure Statemen



IMPORTANT

This equipment complies with IC radiation exposure limits set forth for an uncontrolled environment. This equipment should be installed and operated with a minimum distance of 20cm between the radiator and you.

Caring for the Environment

The following information is provided to enable regulatory compliance with the European Union (EU) Directive 2002/96/EC Waste Electrical and Electronic Equipment (WEEE) when using Motorola Networks equipment in EU countries.



Disposal of Motorola Equipment in EU Countries

This product is compliant with the requirements of the European Union Restriction of Hazardous Substances (EU RoHS) directive.

Please do not dispose of Motorola Networks equipment in landfill sites.

In the EU, Motorola Networks in conjunction with a recycling partner will ensure that equipment is collected and recycled according to the requirements of EU environmental law.

Disposal of Motorola Networks Equipment in Non-EU countries

In non-EU countries, dispose of Motorola Networks equipment in accordance with national and regional regulations.

CMM Disclosure

The China Management Methods (CMM) Disclosure Table is intended only to communicate compliance with China requirements; it is not intended to communicate compliance with EU RoHS or any other environmental requirements.

部件名称	有毒有害物质或元素					
	铅 (Pb)	汞 (Hg)	镉 (Cd)	六价铬 (Cr ⁶⁺)	多溴联苯 (PBB)	多溴二苯醚 (PBDE)
金属部件	×	○	×	×	○	○
电路模块	×	○	×	×	○	○
电缆及电缆组件	×	○	×	×	○	○
塑料和聚合物部件	○	○	○	○	○	×

○： 表示该有毒有害物质在该部件所有均质材料中的含量均在 SJ/T11363-2006 标准规定的限量要求以下。
 ×： 表示该有毒有害物质至少在该部件的某一均质材料中的含量超出 SJ/T11363-2006 标准规定的限量要求。

Copyrights and Trademarks

Notice

While reasonable efforts have been made to assure the accuracy of this document, Motorola, Inc. assumes no liability resulting from any inaccuracies or omissions in this document, or from use of the information obtained herein. The information in this document has been carefully checked and is believed to be entirely reliable. However, no responsibility is assumed for inaccuracies or omissions. Motorola, Inc. reserves the right to make changes to any products described herein and reserves the right to revise this document and to make changes from time to time in content hereof with no obligation to notify any person of revisions or changes. Motorola, Inc. does not assume any liability arising out of the application or use of any product, software, or circuit described herein; neither does it convey license under its patent rights or the rights of others.

It is possible that this publication may contain references to, or information about Motorola products (machines and programs), programming, or services that are not announced in your country. Such references or information must not be construed to mean that Motorola intends to announce such Motorola products, programming, or services in your country.

Copyrights

This instruction manual, and the Motorola products described in this instruction manual may be, include or describe copyrighted Motorola material, such as computer programs stored in semiconductor memories or other media. Laws in the United States and other countries preserve for Motorola and its licensors certain exclusive rights for copyrighted material, including the exclusive right to copy, reproduce in any form, distribute and make derivative works of the copyrighted material. Accordingly, any copyrighted material of Motorola and its licensors contained herein or in the Motorola products described in this instruction manual may not be copied, reproduced, distributed, merged or modified in any manner without the express written permission of Motorola. Furthermore, the purchase of Motorola products shall not be deemed to grant either directly or by implication, estoppel, or otherwise, any license under the copyrights, patents or patent applications of Motorola, as arises by operation of law in the sale of a product.

Usage and Disclosure Restrictions

License Agreements

The software described in this document is the property of Motorola, Inc. and its licensors. It is furnished by express license agreement only and may be used only in accordance with the terms of such an agreement.

Copyrighted Materials

Software and documentation are copyrighted materials. Making unauthorized copies is prohibited by law. No part of the software or documentation may be reproduced, transmitted, transcribed, stored in a retrieval system, or translated into any language or computer language, in any form or by any means, without prior written permission of Motorola, Inc.

High Risk Materials

Components, units, or third-party products used in the product described herein are NOT fault-tolerant and are NOT designed, manufactured, or intended for use as on-line control equipment in the following hazardous environments requiring fail-safe controls: the operation of Nuclear Facilities, Aircraft Navigation or Aircraft Communication Systems, Air Traffic Control, Life Support, or Weapons Systems (High Risk Activities). Motorola and its supplier(s) specifically disclaim any expressed or implied warranty of fitness for such High Risk Activities.

Trademarks

MOTOROLA and the Stylized M Logo are registered in the US Patent & Trademark Office. All other product or service names are the property of their respective owners.

© Motorola, Inc., 2009